



Robit® rod descriptions

Example: TH ROD M/F-R32-32R-R32-0915-FC

TH ROD	M/F	R	32	32	R	R	32	0915	FC
Product Group	Thread Design	Thread Type A	Thread Ø Size [mm]	Steel Ø Size [mm]	Rod Design	Thread Type B	Thread Ø Size [mm]	Rod Length [mm]	Treatment
TH DRIFTER ROD	M/M	R	32-60	25-60	R = Round	R	25-60	0915-6440	FC = Fully carburized
TH ROD	M/F	C			H = Hexagonal	C			
		RG				RG			

Thread type



Material profile



Robit® Drill Rods

- *Produced from the carefully selected hollow drill steels, Robit® drill rods provide the advantages of the maximum strength with long thread life.*
- *Stiff drill steel will provide improved hole straightness.*
- *Automated drill rod production will ensure consistent top quality of Robit® drill rods*
- *Competitive offering of Drifter rods, Extension rods, Drill tubes and Guide tubes to suit all your drilling needs.*
- *Available with most types of threads and standard lengths*



Drifter Rod - R25 (1") bit thread

Order code	Length		Diameter D	Thread		Flushing F	Product number	Weight [kg]	Pcs/box 
	[mm]	[ft - in]		[A]	[B]				

Drifter Rod R32 - Hex25 - R25

TH Drifter Rod M/M R32-25H-R25 2175	2175	7' 1 10/16"	HEX25	R32	R25	8,6	06D-07-6029	8,5	60
TH Drifter Rod M/M R32-25H-R25 2400	2400	7' 10 1/2"	HEX25	R32	R25	8,6	06D-07-6433	9,5	60
TH Drifter Rod M/M R32-25H-R25 2475	2475	8' 1 7/8"	HEX25	R32	R25	8,6	06D-07-5680	9,6	60
TH Drifter Rod M/M R32-25H-R25 2630	2630	8' 7 3/8"	HEX25	R32	R25	8,6	06D-07-6030	10,2	60
TH Drifter Rod M/M R32-25H-R25 2750	2750	9' 1/4"	HEX25	R32	R25	8,6	06D-07-4347	10,6	60
TH Drifter Rod M/M R32-25H-R25 2795	2795	9' 2 1/32"	HEX25	R32	R25	8,6	06D-07-5122	10,8	60
TH Drifter Rod M/M R32-25H-R25 3090	3090	10' 1 5/8"	HEX25	R32	R25	8,6	06D-07-5841	12,0	60
TH Drifter Rod M/M R32-25H-R25 3340	3340	10' 11 1/2"	HEX25	R32	R25	8,6	3000039	13,0	60
TH Drifter Rod M/M R32-25H-R25 4000	4000	13' 1 1/2"	HEX25	R32	R25	8,6	06D-07-6801	15,5	60

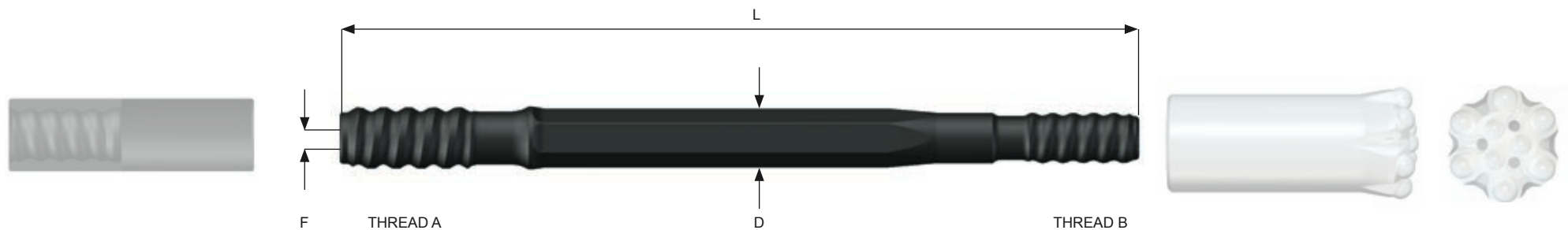

Drifter Rod - R28 (1 1/8") bit thread

Order code	Length		Diameter D	Thread		Flushing F	Product number	Weight [kg]	Pcs/box 
	[mm]	[ft - in]		[A]	[B]				
Drifter Rod R32 - Hex28 - R28									
TH Drifter Rod M/M R32-28H-R28 1870	1870	6' 1 5/8"	HEX28	R32	R28	8,8	3000020	9,5	60
TH Drifter Rod M/M R32-28H-R28 2175	2175	7' 1 10/16"	HEX28	R32	R28	8,8	06D-07-6032	11,0	60
TH Drifter Rod M/M R32-28H-R28 2475	2475	8' 1 7/16"	HEX28	R32	R28	8,8	06D-07-6033	12,5	60
TH Drifter Rod M/M R32-28H-R28 2795	2795	9' 2"	HEX28	R32	R28	8,8	06D-07-6035	14,1	60
TH Drifter Rod M/M R32-28H-R28 3090	3090	10' 1 5/8"	HEX28	R32	R28	8,8	06D-07-6037	15,6	60
TH Drifter Rod M/M R32-28H-R28 3340	3340	10' 11 1/2"	HEX28	R32	R28	8,8	06D-07-0115	16,9	60
TH Drifter Rod M/M R32-28H-R28 3700	3700	12' 1 5/8"	HEX28	R32	R28	8,8	06D-07-6570	18,7	60

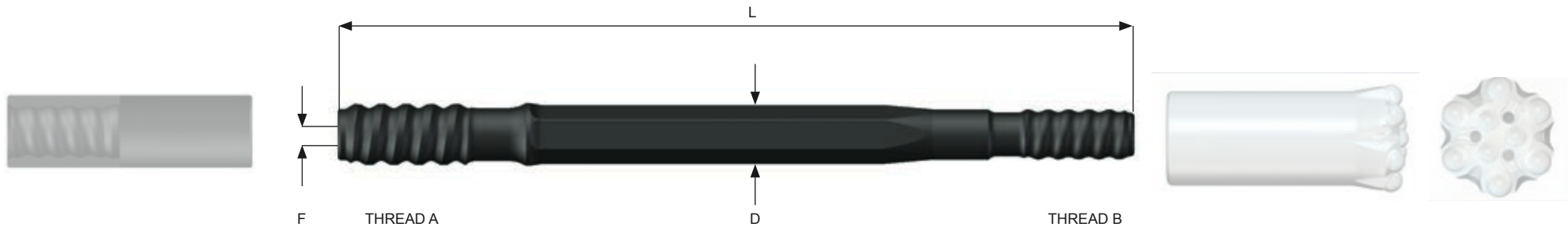

R32 RODS - CONSISTENT HIGH QUALITY

1 ¼" thread

Drifter Rod - R32 (1 ¼") bit thread

Order code	Length		Diameter	Thread		Flushing	Product number	Weight	Pcs/box
	L			D	[A]				
	[mm]	[ft - in]	[mm]			[mm]		[kg]	

Drifter Rod R38 - Hex32 - R32

TH Drifter Rod M/M R38-32H-R32 3090	3090	10' 1 5/8"	HEX32	R38	R32	9,6	06D-07-2886	19,7	50
TH Drifter Rod M/M R38-32H-R32 3700	3700	12' 1 5/8"	HEX32	R38	R32	9,6	06D-07-2887	23,6	40
TH Drifter Rod M/M R38-32H-R32 4305	4305	14' 1 1/2"	HEX32	R38	R32	9,6	06D-07-2143	27,4	30
TH Drifter Rod M/M R38-32H-R32 4915	4915	16' 1 1/2"	HEX32	R38	R32	9,6	06D-07-6438	31,3	30

Drifter Rod R38 - Hex35 - R32

TH Drifter Rod M/M R38-35H-R32 3090	3090	10' 1 5/8"	HEX35	R38	R32	9,5	06D-07-2892	23,9	50
TH Drifter Rod M/M R38-35H-R32 3700	3700	12' 1 5/8"	HEX35	R38	R32	9,5	06D-07-2894	28,7	40
TH Drifter Rod M/M R38-35H-R32 4305	4305	14' 1 1/2"	HEX35	R38	R32	9,5	06D-07-2709	33,5	30

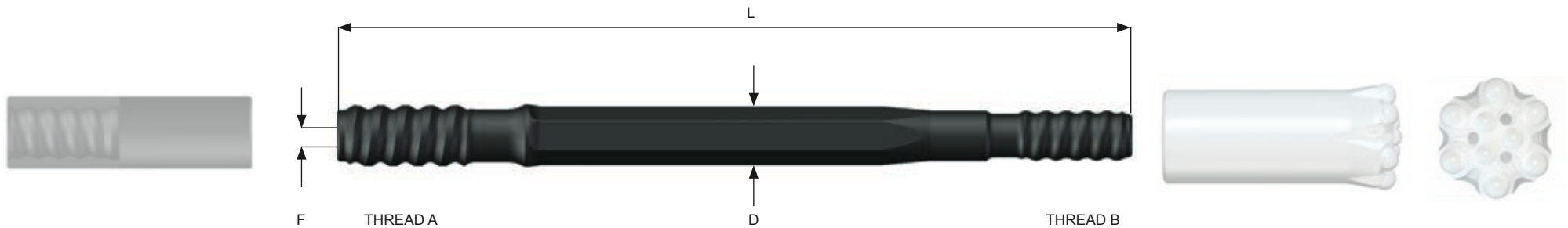

Drifter Rod - R32 (1 ¼") bit thread

Order code	Length		Diameter D	Thread		Flushing F	Product number	Weight [kg]	Pcs/box 
	[mm]	[ft - in]		[A]	[B]				

Drifter Rod C38 - Hex32 - R32

TH Drifter Rod M/M C38-32H-R32 2400	2400	7' 10 ½"	HEX32	C38	R32	9,6	06D-07-3686	15,3	50
TH Drifter Rod M/M C38-32H-R32 3090	3090	10' 1 ⅝"	HEX32	C38	R32	9,6	06D-07-2889	19,7	50
TH Drifter Rod M/M C38-32H-R32 3700	3700	12' 1 ⅜"	HEX32	C38	R32	9,6	06D-07-2890	23,6	50
TH Drifter Rod M/M C38-32H-R32 4305	4305	14' 1 ½"	HEX32	C38	R32	9,6	06D-07-2750	27,4	30

Drifter Rod C38 - Hex35 - R32

TH Drifter Rod M/M C38-35H-R32 3090	3090	10' 1 ⅝"	HEX35	C38	R32	9,5	06D-07-2895	23,9	50
TH Drifter Rod M/M C38-35H-R32 3700	3700	12' 1 ⅝"	HEX35	C38	R32	9,5	06D-07-2897	28,7	40
TH Drifter Rod M/M C38-35H-R32 4305	4305	14' 1 ½"	HEX35	C38	R32	9,5	06D-07-0891	33,5	30
TH Drifter Rod M/M C38-35H-R32 4915	4915	16' 1 ½"	HEX35	C38	R32	9,5	06D-07-3965	38,3	30
TH Drifter Rod M/M C38-35H-R32 5525	5525	18' 1 ½"	HEX35	C38	R32	9,5	06D-07-3966	43,1	30

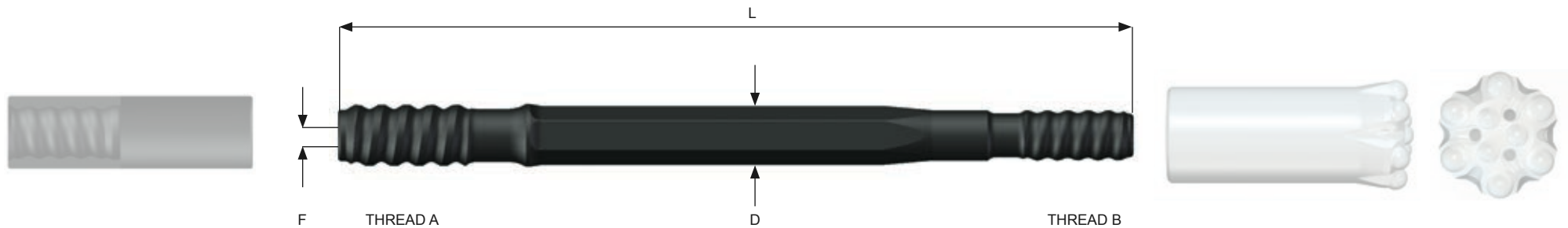

R32 RODS - CONSISTENT HIGH QUALITY

1 1/4" thread

Extension Rod (Male/Male) - R32 (1 1/4") bit thread

Order code	Length		Diameter	Thread		Flushing	Product number	Weight	Pcs/box
	L			D	[A]				
	[mm]	[ft - in]	[mm]			[mm]		[kg]	

Extension M/M Rod R32 - round 32 - R32 - FC (Fully Carburized also suitable for underground)

TH Rod M/M R32 32R 0915 FC	915	3'	RND32	R32	R32	11,7	06A-07-3247	4,6	50
TH Rod M/M R32 32R 1220 FC	1220	4'	RND32	R32	R32	11,7	06A-07-2899	6,3	50
TH Rod M/M R32 32R 1525 FC	1525	5'	RND32	R32	R32	11,7	06A-07-2900	8,0	50
TH Rod M/M R32 32R 1830 FC	1830	6'	RND32	R32	R32	11,7	06A-07-2901	9,7	50

Extension M/M Rod R32 - round 32 - R32

TH Rod M/M R32 32R 3050	3050	10'	RND32	R32	R32	11,7	06A-07-3241	16,5	50
TH Rod M/M R32 32R 3660	3660	12'	RND32	R32	R32	11,7	06A-07-3242	19,8	50

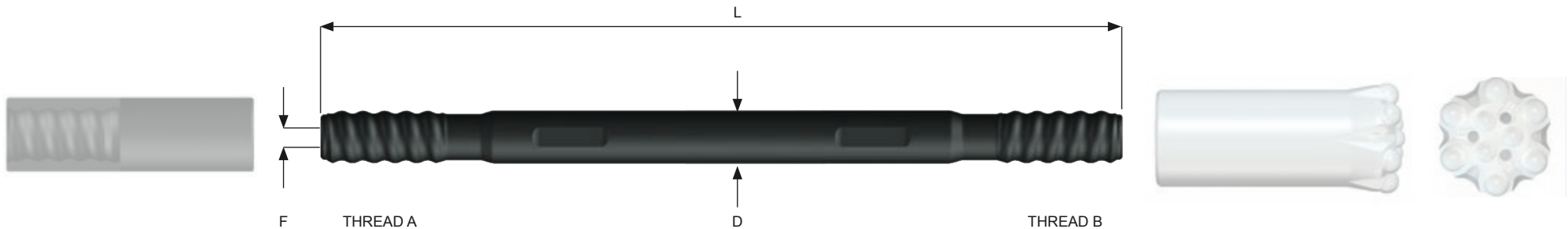

RR34 RODS - CONSISTENT HIGH QUALITY

1 5/16" thread

Drifter Rod - RR34 (1 5/16") bit thread

Order code	Length		Diameter D [mm]	Thread		Flushing F [mm]	Product number	Weight [kg]	Pcs/box 
	L [mm]	[ft - in]		[A]	[B]				

Drifter Rod C38 - RND39 - RR34

TH Drifter Rod M/M C38-39R-RR34 3700	3700	12' 1 5/8"	RND39	C38	RR34	10,3	06D-07-6635	30,0	30
TH Drifter Rod M/M C38-39R-RR34 5525	5525	18' 1 1/2"	RND39	C38	RR34	10,3	06D-07-3971	47,9	20
TH Drifter Rod M/M C38-39R-RR34 6135	6135	20' 1 1/2"	RND39	C38	RR34	10,3	06D-07-3972	51,2	20
TH Drifter Rod M/M C38-39R-RR34 6440	6440	21'	RND39	C38	RR34	10,3	06D-07-3973	55,4	20

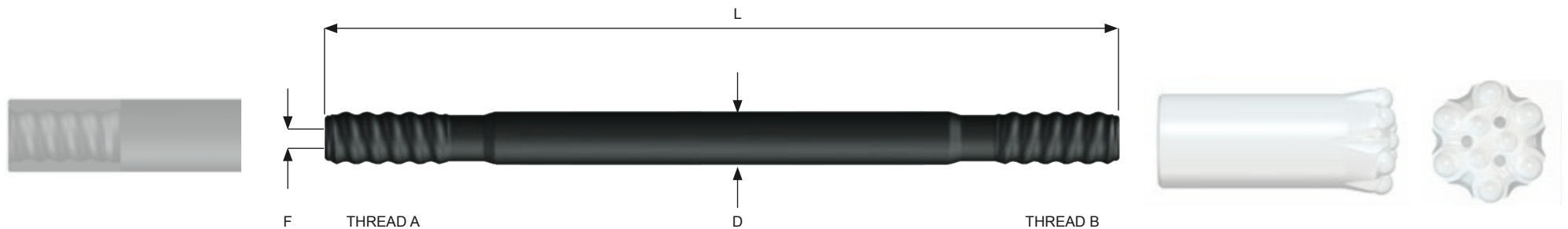

TOP PERFORMANCE - RODS **RR34**

1 5/16" thread

Drifter Rod - RR34 (1 5/16") bit thread

Order code	Length		Diameter D [mm]	Thread		Flushing F [mm]	Product number	Weight [kg]	Pcs/box 
	L [mm]	[ft - in]		[A]	[B]				
Drifter Rod C38 - Hex35 - RR34									
TH Drifter Rod M/M C38-35H-RR34 3700	3700	12' 1 5/8"	HEX35	C38	RR34	9,5	06D-07-5324	28,7	40
TH Drifter Rod M/M C38-35H-RR34 4305	4305	14' 1 1/2"	HEX35	C38	RR34	9,5	06D-07-3967	33,5	30
TH Drifter Rod M/M C38-35H-RR34 4915	4915	16' 1 1/2"	HEX35	C38	RR34	9,5	06D-07-3968	38,2	30
TH Drifter Rod M/M C38-35H-RR34 5525	5525	18' 1 1/2"	HEX35	C38	RR34	9,5	06D-07-3969	43,0	30

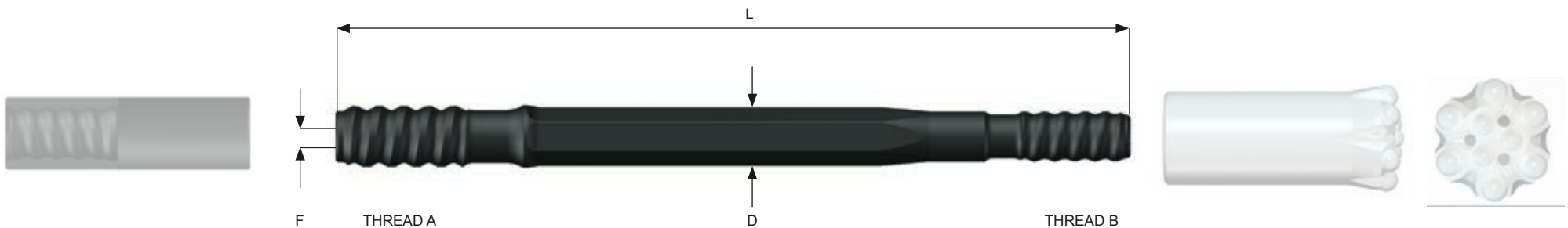

Extension Rod (Male/Female) - R32 (1 1/4") bit thread

Order code	Length		Diameter	Thread		Flushing	Product number	Weight	Pcs/box
	L			D	[A]				
	[mm]	[ft - in]	[mm]			[mm]		[kg]	

Extension M/F Rod R32 - round 32 - R32 - FC (Fully Carburized also suitable for underground)

TH Rod M/F R32 32R 0915 FC	915	3'	RND32	R32	R32	11,7	06B-07-2910	5,3	40
TH Rod M/F R32 32R 1220 FC	1220	4'	RND32	R32	R32	11,7	06B-07-2876	7,3	40
TH Rod M/F R32 32R 1525 FC	1525	5'	RND32	R32	R32	11,7	06B-07-2419	8,9	40
TH Rod M/F R32 32R 1830 FC	1830	6'	RND32	R32	R32	11,7	06B-07-3020	10,5	40

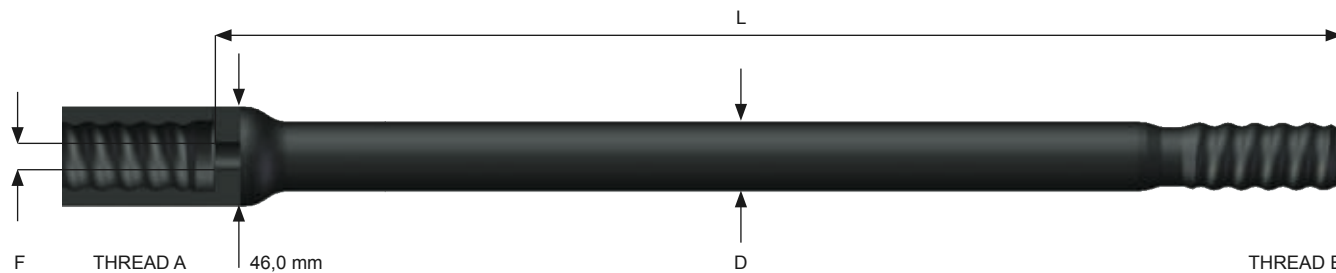

Extension Rod (Male/Female) - C38 (1 1/2") bit thread

Order code	Length		Diameter D [mm]	Thread		Flushing F [mm]	Product number	Weight [kg]	Pcs/box 
	L [mm]	[ft - in]		[A]	[B]				

Extension M/F Rod C38 - round 39 - C38 - FC (Fully Carburized also suitable for underground)

TH Rod M/F C38 39R 1220 FC	1220	4'	RND39	C38	C38	14,5	06B-07-2911	10,9	32
TH Rod M/F C38 39R 1525 FC	1525	5'	RND39	C38	C38	14,5	06B-07-2420	13,5	24
TH Rod M/F C38 39R 1830 FC	1830	6'	RND39	C38	C38	14,5	06B-07-2879	16,0	24

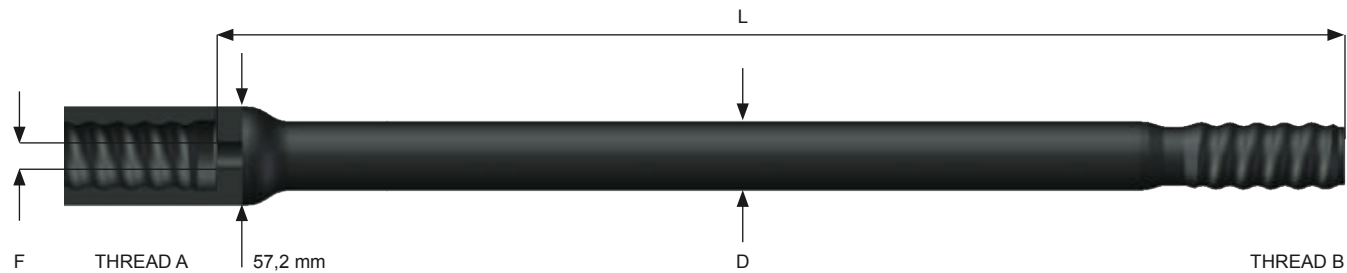

Extension Rod (Male/Female) - C45 (1 3/4") bit thread

Order code	Length		Diameter	Thread		Flushing	Product number	Weight	Pcs/box
	L			D	[A]				
	[mm]	[ft - in]	[mm]			[mm]		[kg]	
Extension M/F Rod C45 - round 46 - C45 - FC (Fully Carburized also suitable for underground)									
TH Rod M/F C45 46R 1525 FC	1525	5'	RND46	C45	C45	17,0	06B-07-2421	18,3	24
TH Rod M/F C45 46R 1830 FC	1830	6'	RND46	C45	C45	17,0	06B-07-3019	22,0	24



RODS - CONSISTENT HIGH QUALITY

C51
2" thread

Long Hole Drilling

Extension Rod (Male/Female) - C51 (2") bit thread

Order code	Length		Diameter	Thread		Flushing	Product number	Weight	Pcs/box
	L			D	[A]				
	[mm]	[ft - in]	[mm]			[mm]		[kg]	
Extension M/F Rod C51 - round 52 - C51 - FC (Fully Carburized also suitable for underground)									
TH Rod M/F C51 52R 1525 FC	1525	5'	RND52	C51	C51	21,5	06B-07-3248	22,3	18
TH Rod M/F C51 52R 1830 FC	1830	6'	RND52	C51	C51	21,5	06B-07-2883	26,8	18

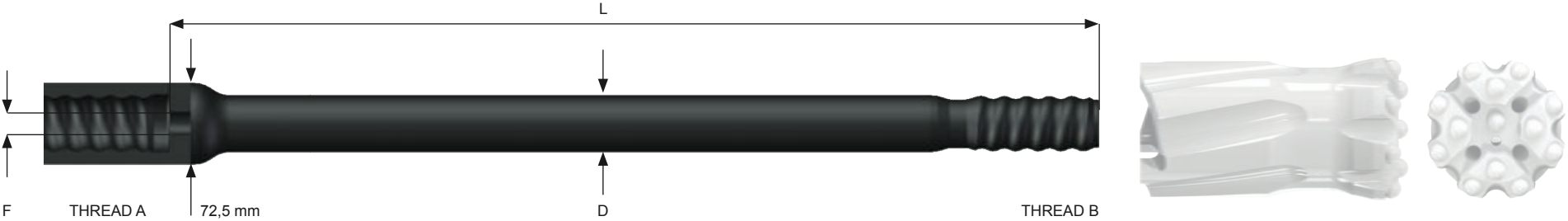

Extension Rod (Male/Female & Male/Male) - R32 (1 1/4") bit thread

Order code	Length		Diameter D [mm]	Thread		Flushing F [mm]	Product number	Weight [kg]	Pcs/box 
	L [mm]	[ft - in]		[A]	[B]				

Extension M/F Rod R32 - round 32 - R32

TH Rod M/F R32 32R 3050	3050	10'	RND32	R32	R32	11,7	06B-07-2877	17,1	32
TH Rod M/F R32 32R 3660	3660	12'	RND32	R32	R32	11,7	06B-07-2492	20,9	32

Extension M/M Rod R32 - round 32 - R32

TH Rod M/M R32 32R 3050	3050	10'	RND32	R32	R32	11,7	06A-07-3241	16,5	50
TH Rod M/M R32 32R 3660	3660	12'	RND32	R32	R32	11,7	06A-07-3242	19,8	50

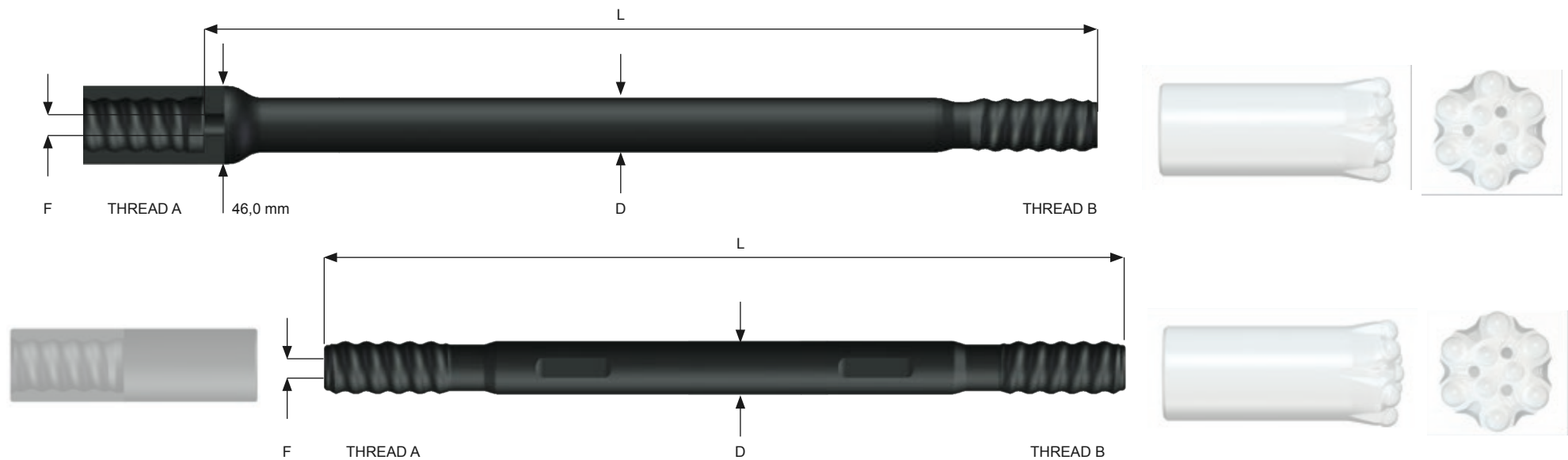

Extension Rod (Male/Female & Male/Male) - C38 (1 1/2") bit thread

Order code	Length		Diameter D [mm]	Thread		Flushing F [mm]	Product number	Weight [kg]	Pcs/box 
	L [mm]	[ft - in]		[A]	[B]				
Extension M/F Rod C38 - round 39 - C38									
TH Rod M/F C38 39R 3050	3050	10'	RND39	C38	C38	14,5	06B-07-2199	25,6	24
TH Rod M/F C38 39R 3660	3660	12'	RND39	C38	C38	14,5	06B-07-2491	30,4	24
TH Rod M/F C38 39R 4265	4265	14'	RND39	C38	C38	14,5	06B-07-3243	35,2	24
Extension M/M Rod C38 - round 39 - C38									
TH Rod M/M C38 39R 3050	3050	10'	RND39	C38	C38	14,5	06A-07-0492	24,3	50
TH Rod M/M C38 39R 3660	3660	12'	RND39	C38	C38	14,5	06A-07-0491	29,2	40

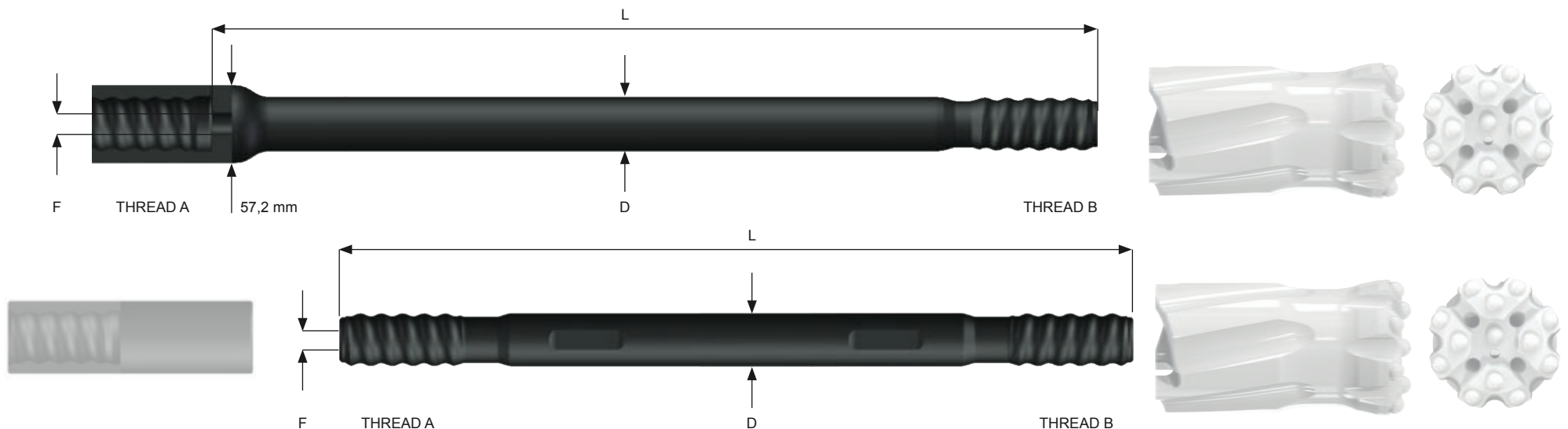

Surface Drilling

C45 RODS - CONSISTENT HIGH QUALITY

1 3/4" thread

Extension Rod (Male/Female) - C45 (1 3/4") bit thread

Order code	Length		Diameter D [mm]	Thread		Flushing F [mm]	Product number	Weight [kg]	Pcs/box 
	L [mm]	[ft - in]		[A]	[B]				
Extension M/F Rod C45 - round 46 - C45									
TH Rod M/F C45 46R 3050	3050	10'	RND46	C45	C45	17,0	06B-07-2882	35,7	24
TH Rod M/F C45 46R 3660	3660	12'	RND46	C45	C45	17,0	06B-07-0501	42,5	24
TH Rod M/F C45 46R 4265	4265	14'	RND46	C45	C45	17,0	06B-07-2912	49,5	24
TH Rod M/F C45 46R 6095	6095	20'	RND46	C45	C45	17,0	06B-07-3244	69,0	16



Extension Rod (Male/Male) - C45 (1 3/4") bit thread

Order code	Length		Diameter D [mm]	Thread		Flushing F [mm]	Product number	Weight [kg]	Pcs/box 
	L [mm]	[ft - in]		[A]	[B]				
Extension M/M Rod C45 - round 46 - C45									
TH Rod M/M C45 46R 3050	3050	10'	RND46	C45	C45	17,0	06A-07-0489	33,6	30
TH Rod M/M C45 46R 3660	3660	12'	RND46	C45	C45	17,0	06A-07-2905	40,4	30
TH Rod M/M C45 46R 4265	4265	14'	RND46	C45	C45	17,0	06A-07-2906	47,1	25

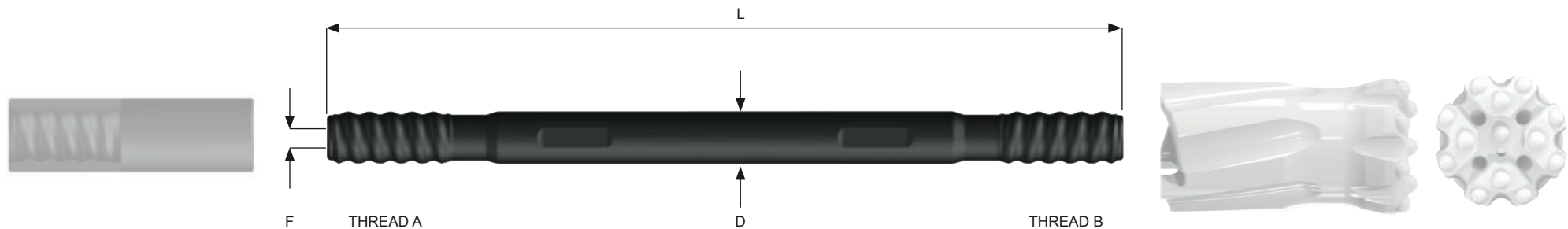

C51

2" thread

RODS - CONSISTENT HIGH QUALITY

Extension Rod (Male/Female) - C51 (2") bit thread

Order code	Length		Diameter D [mm]	Thread		Flushing F [mm]	Product number	Weight [kg]	Pcs/box 
	L [mm]	[ft - in]		[A]	[B]				

Extension M/F Rod C51 - round 52 - C51

TH Rod M/F C51 52R 3660	3660	12'	RND52	C51	C51	21,5	06B-07-0500	52,5	18
TH Rod M/F C51 52R 4265	4265	14'	RND52	C51	C51	21,5	06B-07-2884	61,0	18
TH Rod M/F C51 52R 6095	6095	20'	RND52	C51	C51	21,5	06B-07-3245	85,6	12

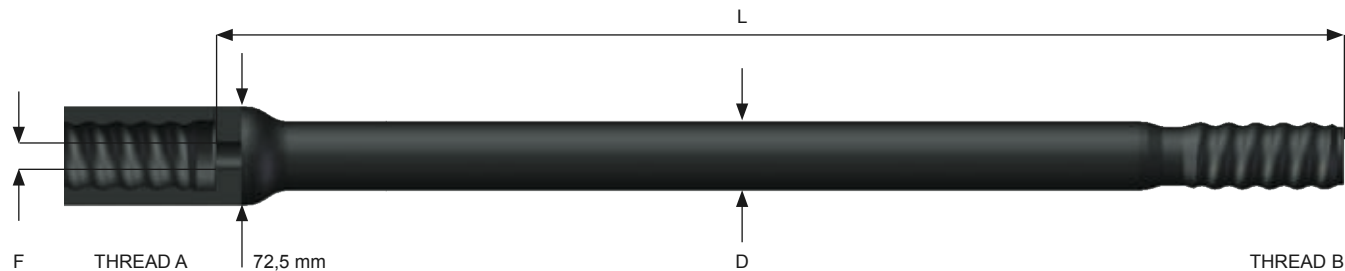

Extension Rod (Male/Male) - C51 (2") bit thread

Order code	Length		Diameter D [mm]	Thread		Flushing F [mm]	Product number	Weight [kg]	Pcs/box 
	L [mm]	[ft - in]		[A]	[B]				
Extension M/M Rod C51 - round 52 - C51									
TH Rod M/M C51 52R 3660	3660	12'	RND52	C51	C51	21,5	06A-07-2536	49,8	25
TH Rod M/M C51 52R 4265	4265	14'	RND52	C51	C51	21,5	06A-07-2909	58,1	20
TH Rod M/M C51 52R 6095	6095	20'	RND52	C51	C51	21,5	06A-07-3246	83,5	15

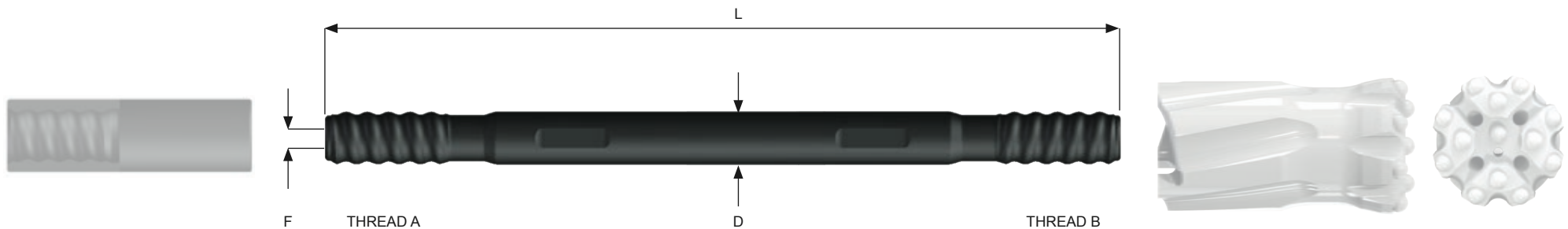

Surface Drilling

TOP PERFORMANCE - RODS **RG60**

2 1/3" thread

Extension Rod (Male/Female) - RG60 (2 1/3") bit thread

Order code	Length		Diameter D [mm]	Thread		Flushing F [mm]	Product number	Weight [kg]	Pcs/box 
	L [mm]	[ft - in]		[A]	[B]				

Extension M/F Rod RG60 - round 60 - RG60 (for bits from 96 mm)

TH Rod M/F RG60 60R 3660	3660	12'	RND60	RG60	RG60	22,5	06B-07-3358	74,1	12
TH Rod M/F RG60 60R 4265	4265	14'	RND60	RG60	RG60	22,5	06B-07-0502	85,7	12
TH Rod M/F RG60 60R 6095	6095	20'	RND60	RG60	RG60	22,5	06B-07-3359	120,5	10

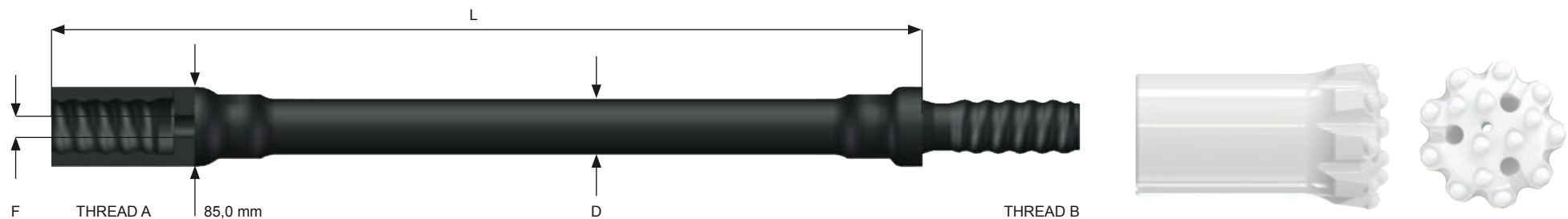

Surface
Drilling